



N° d'ordre :

N° de série :

People's Democratic Republic of Algeria
Ministry Of Higher Education And Scientific Research
University Of Ghardaia
Faculty of Science and Technology
Department of Automatics and Electromechanics

A thesis submitted in fulfillment of the requirements for the degree of
MASTER

Domain: Sciences and Technologies

Branch: Automatics

Specialty: Automatics and systems

THEME

Aquaponic Vertical Farming Tower: An Innovative Automated System with Bio Feeding

By:

HAMDI MAROUANE

BOHADDA NADIR

Defended publicly on 20/07/2024

In front of the jury:

BITEUR Kada	RANK	Univ. Ghardaïa	President
FIHA KHEIR Mehdi	RANK	Univ. Ghardaïa	Examiner
HACENE Nacer	MCA	Univ. Ghardaïa	Supervisor

Academic year 2024/2025

Acknowledgment

All praises and thanks to Almighty ALLAH, the most beneficent and the most merciful, who gave us all abilities and helped us to complete this humble work,

I would like to express my sincere gratitude to my supervisor HACENE Nacer for his support and guidance during the course of this work. His encouragement and guidance have always been a source of motivation. It was an honor to work under his supervision.

Special thanks go to our professors, academic staff, and personnel at the University of Ghardaia.

Most importantly, I am grateful to my family who supported me every time I was in need, always standing by me and guiding me through life. I would like to thank them for their unconditional love that motivates me to aim higher.

Thanks!

ملخص

يهدف هذا العمل إلى تطوير جهاز مبتكر يدمج بين الزراعة العمودية للنباتات وتربية الأسماك في وحدة واحدة. يركز الجهاز على تعزيز الاستدامة من خلال إعادة تدوير المياه واستخدام مخلفات الأسماك كمغذيات للنباتات، مما يقلل من استهلاك الموارد ويحسن الإنتاج الزراعي. الجهاز مناسب للمساحات الصغيرة مثل المنازل ويعمل كعنصر ديكوري يجمع بين الجمال والفائدة. يمكن استخدامه أيضاً كمزرعة متكاملة لتربية الأسماك وزراعة المحاصيل بربط عدة وحدات معاً. يتميز الجهاز بنظام تحكم آلي متطور يقيس نقاوة المياه، يراقب مستويات العناصر الغذائية، ويتحكم في شدة الإضاءة، مما يسهل على المستخدمين إدارة الوحدة بفعالية.

Abstract

This work aims to develop an innovative device that integrates vertical plant farming with fish breeding in a single unit. The device focuses on enhancing sustainability by recycling water and using fish waste as nutrients for the plants, thereby reducing resource consumption and improving agricultural production.

The device is suitable for small spaces such as homes and serves as a decorative element that combines beauty and utility. It can also be used as an integrated farm for fish breeding and crop cultivation by linking several units together.

The device features an advanced automated control system that measures water purity, monitors nutrient levels, and controls light intensity, making it easy for users to effectively manage the unit.

Résumé

Ce travail vise à développer un dispositif innovant qui intègre la culture verticale de plantes avec l'élevage de poissons dans une seule unité. Le dispositif met l'accent sur l'amélioration de la durabilité en recyclant l'eau et en utilisant les déchets de poissons comme nutriments pour les plantes, réduisant ainsi la consommation de ressources et améliorant la production agricole.

Le dispositif est adapté aux petits espaces tels que les maisons et sert d'élément décoratif alliant beauté et utilité. Il peut également être utilisé comme une ferme intégrée pour l'élevage de poissons et la culture de cultures en reliant plusieurs unités ensemble.

Le dispositif dispose d'un système de contrôle automatisé avancé qui mesure la pureté de l'eau, surveille les niveaux de nutriments et contrôle l'intensité lumineuse, facilitant ainsi la gestion efficace de l'unité par les utilisateurs.

List of Figures

1	including Deep Water Culture (DWC)	8
2	Nutrient Film Technique (NFT)	9
3	Drip-Irrigation-System	10
4	Aeroponic-System	11
5	Ebb-and-flow-system	12
6	Wick System	13
7	The basic flow of an aquaponics system (What is Aquaponics)	16
8	Media-based aquaponic system	17
9	Nutrient Film Technique (NFT) Aquaponics Systems	18
11	Vertical Aquaponics	19
12	esp32 architecture	22
13	ESP32	27
14	rtc real time clock	28
15	PH sensor	29
16	Total Dissolved Solids(tds) sensor	30
17	Waterproof 1-Wire DS18B20 Digital temperature sensor	31
18	Relay Module (8 Channels - 5V)	31
19	servo motor	32
20	Circuit diagram	33
21	Flowchart of the Initial Setup and Main Loop Operations	34
22	How MQTT Protocol Works with NODE RED	36
23	NODE RED FLAW	36
24	Prototype	37
25	This project is registered as a patent	46
26	This project is registered as a patent.	47
27	Permission to print (Master's thesis)	48

List of Tables

1	Fuzzy Logic Rules for Servo Position Control	35
---	--------------------------------------------------------	----

List of Abbreviations

IoT	Internet of Things
DWC	Deep Water Culture
NFT	Nutrient Film Technique
GPIO	General Purpose Input/Output
SPI	Serial Peripheral Interface
I2C	Inter-Integrated Circuit
UART	Universal Asynchronous Receiver Transmitter
ADC	Analog-to-Digital Converter
DAC	Digital-to-Analog Converter
SAR ADC	Successive Approximation Register Analog-to-Digital Converter (a specific type of ADC)
SD/eMMC/SDIO	Secure Digital / embedded MultiMediaCard / Secure Digital Input/Output
Ethernet MAC	Media Access Control (for Ethernet)
CAN	Controller Area Network
RMT	Remote control
PWM	Pulse Width Modulation
LED PWM	Light Emitting Diode Pulse Width Modulation
RTC	Real-Time Clock
MQTT	Message Queuing Telemetry Transport

Contents

Acknowledgment	III
Abstract	IV
List of Figures	V
List of Tables	VI
List of Abbreviations	VII
General introduction	1
chapter 1	5
1 Generalities about hydroponics	5
1.1 Introduction:	6
1.2 What is Hydroponics?:	6
1.3 Hydroponics History :	6
1.4 The Different Types of Hydroponics Systems	7
1.4.1 including Deep Water Culture (DWC)	7
1.4.2 Nutrient Film Technique (NFT)	8
1.4.3 Drip Irrigation	9
1.4.4 Aeroponics	10
1.4.5 Ebb and Flow	11
1.4.6 Wick System	12
1.5 Conclusion:	13
chapter 2	14
2 Generalities about Aquaponics and ESP32	14
2.1 Introduction	15
2.2 What is Aquaponics?:	15
2.3 Types of aquaponics	16
2.3.1 Media Based Aquaponics System	16
2.3.2 Nutrient Film Technique (NFT) Aquaponics Systems	17
2.3.3 Raft Aquaponics System	18
2.3.4 Vertical Aquaponics	19
2.4 ESP32 Platform	20
2.4.1 Why ESP32?	20
2.4.2 Hardware	21
2.4.3 Software	22

2.5	The Internet of Things (IoT):	23
2.5.1	BLYNK:	23
2.5.2	Thing speak	23
2.5.3	MQTT protocol	24
2.5.4	NODE-RED	24
2.6	Conclusion:	25
chapter 3		26
3	Prototype and Development	26
3.1	Introduction	27
3.2	Components:	27
3.2.1	ESP32:	27
3.2.2	RTC:	27
3.2.3	PH sensor:	28
3.2.4	Total Dissolved Solids(tds) sensor:	29
3.2.5	Waterproof 1-Wire DS18B20 Digital temperature sensor:	30
3.2.6	Relay Module (8 Channels - 5V) :	31
3.2.7	servo motor:	32
3.3	Electrical Design :	32
3.4	Software :	33
3.5	Fuzzy Logic :	34
3.6	MQTT (Message Queuing Telemetry Transport):	35
3.7	Node-RED:	36
3.8	Model Deployment	36
3.9	Conclusion	37
Conclusion		38
References		40
Appendix		46
A	Appendix Title	46

General introduction

General Introduction

Advancements in technology are aligning with growing human needs, continually simplifying daily life.

The increasing interest in self-sufficiency and rapid technological advancement has led many countries to focus on advancing agricultural practices. They aim to achieve food production self-sufficiency and enhance productivity through modern methods and technologies, including artificial intelligence. Investing in modern technology is seen as crucial for improving competitiveness in agriculture and ensuring environmental and economic sustainability. This project explores an aquaponic system that integrates aquaculture and hydroponics in a symbiotic relationship, optimizing water usage[1].

Sustainable agriculture farming is a method of preserving nature without compromising the future generation's basic needs, whilst also improving the effectiveness of farming. The basic accomplishments of smart farming in terms of sustainable agriculture are crop rotation, the control of nutrient deficiency in crops, the control of pests and diseases, recycling, and water harvesting, leading to an overall safer environment.[2].

Smart Farming System Defined as the design and use of advanced automated systems in agriculture alongside the increase in industrial agricultural activities. Automated systems in smart farming can be designed to perform specific tasks such as planting, irrigation, fertilization, and others, as needed. These systems are programmed using one of the following methods:

On line

- Teach pendant
- Lead trough programming

Off line

- Robot programming languages
- Task level programming

This Thesis mainly focuses on the Teach pendant programming method to control Smart Farming System using ESP 32.

Thesis Objectives

The primary objective of this Thesis is to design and implement an innovative Smart Farming System that is both environmentally friendly and automated, incorporating bio-feeding methods. The system will leverage advanced technologies such as the Internet of Things (IoT), sensors, and data analytics to optimize agricultural processes. With a focus on sustainability, the Smart Farming System aims to enhance crop yields and resource efficiency while reducing environmental impact and waste. The system's adaptability will allow it to perform a variety of tasks, from monitoring soil health to managing water resources, ensuring that it meets the diverse needs of modern sustainable agriculture.

the thesis is organized as follows:

Chapter 1: Generalities about Hydroponics This chapter provides a comprehensive introduction to the concept of hydroponics, exploring the fundamental principles of this water-based agricultural technique. It delves into the historical context and major developments within the field of hydroponics, detailing various methods and technologies used in smart farming systems. Additionally, the chapter highlights the role of hydroponics in enhancing agricultural productivity through efficient water utilization.

Chapter 2: Generalities about Aquaponics and ESP32 In this chapter, we outline the theoretical framework and technical specifications of aquaponics and the ESP32 control unit. We examine how biological systems in aquaponics interact with electronic technologies, emphasizing the integration of hardware and software components in creating a holistic and sustainable farming environment. Furthermore, we explore the environmental benefits of aquaponics, including improved water quality and reduced ecological impact.

Chapter 3: Prototype and Development This chapter presents the design and implementation of a prototype Smart Farming System. We discuss the integrated approach to combining hardware and software components, illustrating the system's architecture through diagrams and schematics. The software design is

explained using flowcharts, revealing the algorithmic logic behind the bio-feeding process and environmental monitoring.

Finally, the conclusion summarizes the innovative aspects of Smart Farming Systems and their impact on modern agriculture. It offers insights into potential future enhancements and the evolving landscape of eco-friendly farming practices. A curated list of references follows for readers interested in further exploring smart agriculture technologies.

Chapter 1

1 Generalities about hydroponics

1.1 Introduction:

In this chapter, we will explore the various types of hydroponic systems, which allow plants to grow without soil by using nutrient-rich water solutions. The primary types include the Nutrient Film Technique (NFT), where a thin film of nutrient solution flows over plant roots; Deep Water Culture (DWC), where plant roots are submerged in oxygenated nutrient solution; Wick System, which uses a wick to draw nutrient solution to plant roots from a reservoir; Ebb and Flow, which periodically floods and drains the roots with nutrient solution; Drip System, which drips nutrient solution directly onto the base of each plant; and Aeroponics, where plant roots are suspended in the air and misted with nutrient solution. These systems offer faster growth, higher yields, and the ability to grow plants in various environments.

1.2 What is Hydroponics?:

The term hydroponics stems from the ancient Greek composition of "hydro," meaning water, and "ponics," meaning labor. Water is the active agent here, facilitating the rapid growth of plants.

Essentially, hydroponics entails a method of cultivating plants. However, instead of utilizing soil, hydroponics relies on a water-based solution enriched with nutrients. While the concept might appear as a recent innovation, it has, in fact, existed for thousands of years and played a role in sustaining population growth amid diminishing availability of arable land[3].

1.3 Hydroponics History :

By the 16th century, Belgian Jan van Helmont conducted pioneering science-based research on hydroponics, noting that water served as a conduit for delivering nutrients to plants. Expanding on van Helmont's findings, John Woodward developed the world's inaugural hydroponic nutrient solution in 1699. Woodward's conclusion was that plant growth thrived with nutrients dissolved in water, a method more efficient than soil-based cultivation.

The 20th century witnessed a surge of research and progress in cultivation methods. In the late 1920s, Dr. William F. Gericke of the University of California transitioned laboratory experiments into practical applications for commercial crop cultivation outdoors. He introduced the term "hydroponics," derived from the Greek words "hydro," meaning water, and "ponos," meaning labor or work. Gericke's pioneering work laid the foundation for modern hydroponic agriculture.

In more recent times, the US Military has contributed to hydroponic innovations, often driven by exigency. One notable example is Wake Island, an atoll in the Pacific Ocean frequently used as a refueling stop. Its rocky terrain precluded traditional farming methods. To address this, the US Air Force implemented small-scale hydroponic systems covering 120 square feet, which yielded a weekly harvest of 90 pounds of fresh produce[4].

1.4 The Different Types of Hydroponics Systems

Hydroponic systems are gaining popularity as an alternative method for cultivating plants without soil. There are various types of hydroponic systems, including Deep Water Culture (DWC), Nutrient Film Technique (NFT), Drip Irrigation, Aeroponics, Ebb and Flow, and Wick System. Each system offers distinct features and advantages, such as the method of delivering nutrient solution to the plant roots or the choice of medium used to support plant growth. However, what unites all these systems is their reliance on a water-based solution to supply essential nutrients to the plants. Keep reading to explore the different types of hydroponic systems further and understand how they contribute to the cultivation of healthy plants[5].

1.4.1 including Deep Water Culture (DWC)

Deep Water Culture systems, commonly known as "DWC," represent the fusion of simplicity and efficiency. As a method for hydroponic growing, these systems provide an accessible entry point into the world of hydroponics. With their popularity soaring among both hobbyists and commercial growers, DWC systems have proven their worth as a top choice for interested growers.

Hydroponics, distinct from aquaponics, involves growing plants without soil, using a water/nutrient mix. This technique has gained significant attention due to its sustainability and efficiency. DWC systems exemplify these attributes, promoting rapid plant growth and high yields, all while offering an easy and affordable setup[6].

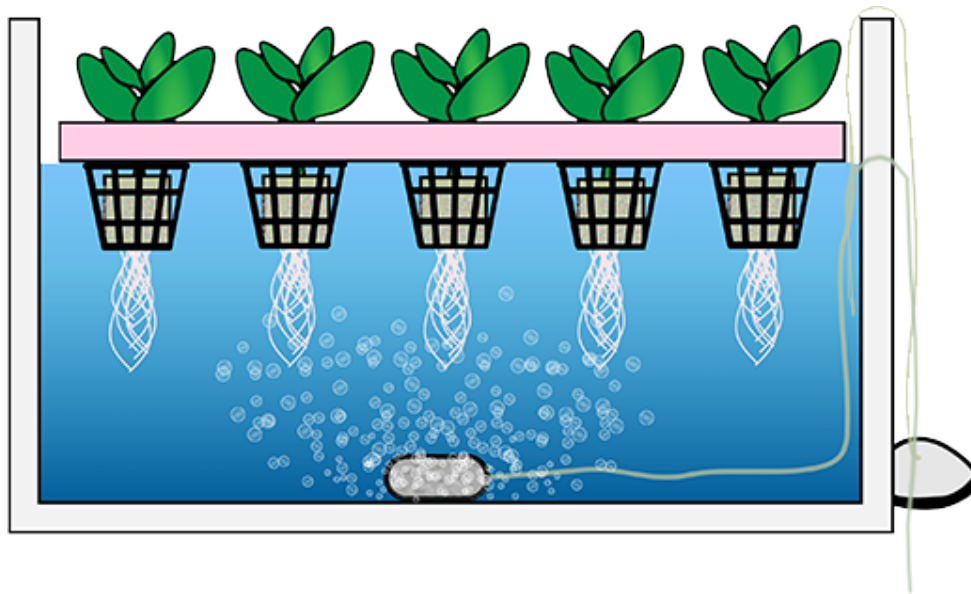

Figure 1: including Deep Water Culture (DWC)

1.4.2 Nutrient Film Technique (NFT)

The Nutrient Film Technique, commonly known as NFT, is a highly efficient and very popular method of hydroponic gardening. This technique relies on a continuous flow of nutrient-rich water over the roots of plants, which are placed in special channels or tubes. This technique gains its popularity from its simplicity, space efficiency, and the ability to continuously provide plants with nutrients, water, and oxygen.

NFT systems are among the most commonly used by hobbyists, operating through a combination of optimal nutrient delivery and efficient oxygenation. Inside the channel, the roots of the plants hang partially suspended in the nutrient solution. This setup ensures that the lower portion of the roots absorbs water and nutrients, while the upper part remains exposed to air, allowing for oxygen absorption. The enclosed, dark environment inside the channel mimics natural

conditions, enhancing the cool and dark conditions typically found in soil.

This article delves deeply into NFT systems, covering their designs, considerations, advantages, disadvantages, and the essential materials required to get started. Whether you are an experienced hydroponic farmer or a beginner interested in sustainable gardening practices, this guide provides comprehensive insights into the world of NFT hydroponics[7].

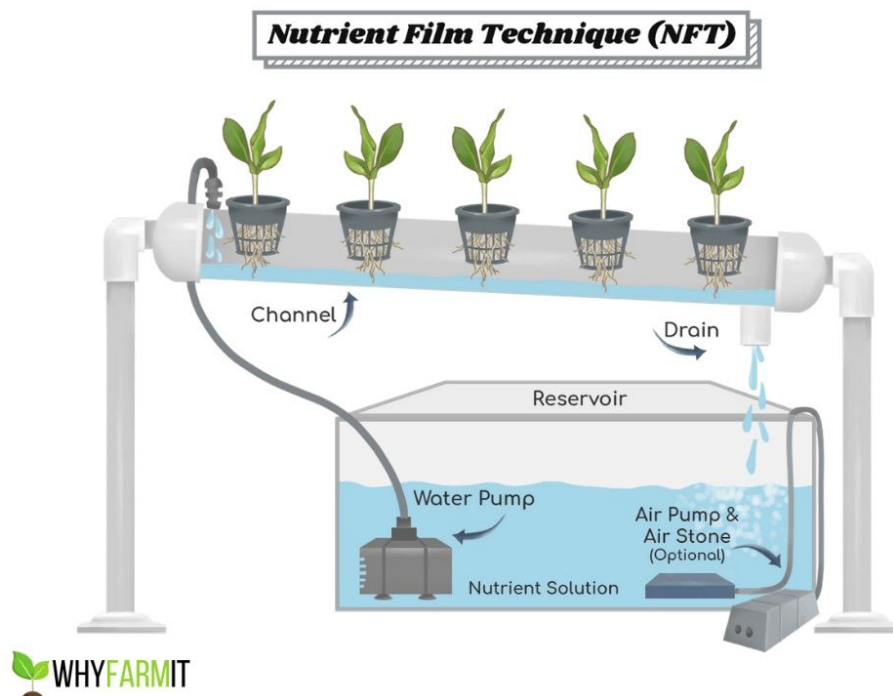

Figure 2: Nutrient Film Technique (NFT)

1.4.3 Drip Irrigation

Drip systems are among the most widely used hydroponic systems globally. Unlike the passive nature of wick systems, drip systems are active, employing a pump to regularly deliver nutrients and water to the plant roots. This concept is also utilized in soil gardens to water plants, with both methods effectively providing the necessary hydration and nutrients for plant growth.

Consider it this way: when watering plants in a soil garden, we often spray a large amount of water over the plants, hoping that enough of it seeps into the soil and reaches the root system. This process involves many factors that can hinder root hydration. Drip systems, on the other hand, deliver water and nutrients directly to the plant roots, significantly reducing water usage and ensuring efficient hydration[8].

Drip System

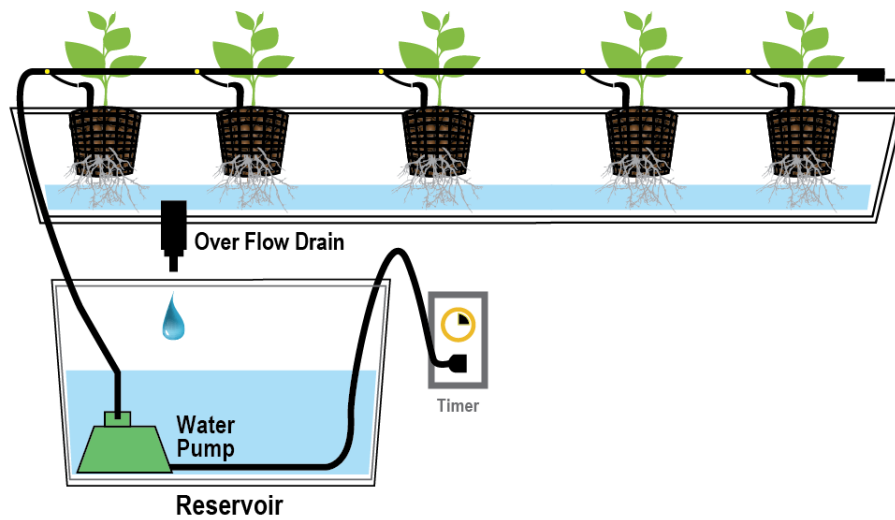

Figure 3: Drip-Irrigation-System

1.4.4 Aeroponics

Aeroponic systems nourish plants with nutrient-laden mist. This concept builds on hydroponic systems, where roots are held in a soilless growing medium, such as coco coir, and nutrient-rich water is periodically pumped over them. Aeroponics eliminates the growing medium, leaving the roots to dangle in the air, where they are periodically sprayed with nutrient mist by specially designed misting devices.

In aeroponic systems, seeds are "planted" in pieces of foam inserted into small pots, exposed to light on one end and nutrient mist on the other. The foam also supports the stem and root mass in place as the plants grow^[9].

Aeroponic System

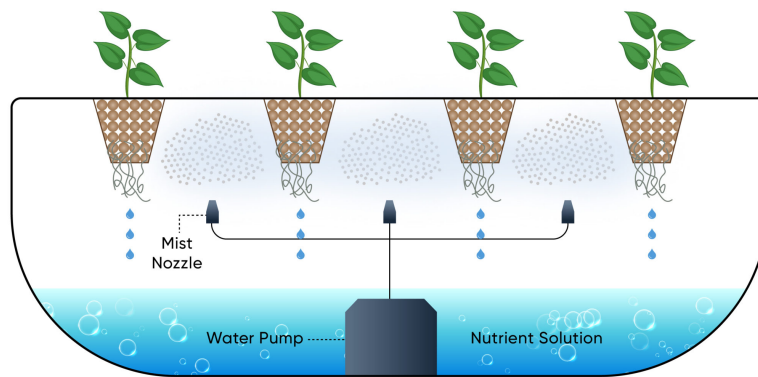

Figure 4: Aeroponic-System

1.4.5 Ebb and Flow

The ebb and flow hydroponic system is a method of growing plants in water without soil. It utilizes standard aquarium pumps to circulate water. This system is one of the most popular methods for hydroponic gardening due to its minimal labor requirements, excellent results, and the ideal environment it provides for root growth. In this widely used approach, the roots of plants are held within a net pot or tray, typically made of plastic, and water is moved from one area to another to ensure ample oxygenation and root aeration.

In an ebb and flow hydroponic system, nutrient-rich water is continuously pumped through a drain at the bottom of the growth basin. This water is then captured by a pump, either through gravity or siphon action, to be recycled and recirculated repeatedly. Once properly set up, the system is quite easy to maintain[10].

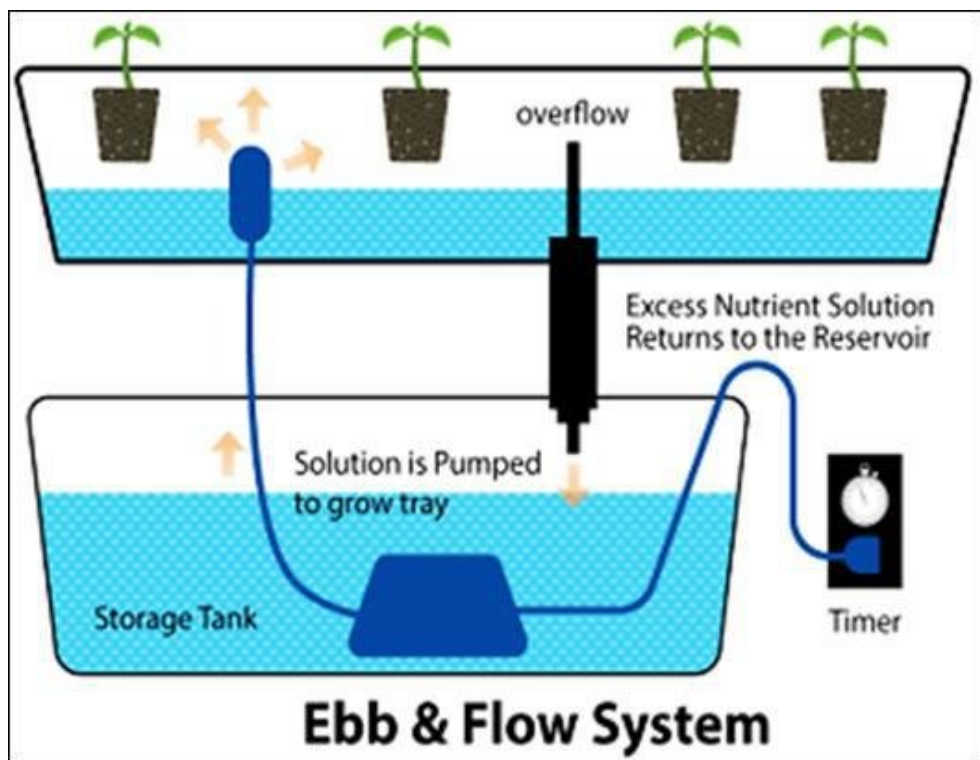

Figure 5: Ebb-and-flow-system

1.4.6 Wick System

Hydroponic wick systems are a type of soilless gardening that allow you to grow plants using only water, nutrients, and a wicking material. These systems are easy to set up and operate, making them a popular choice for beginners and first-time growers.

In a wick system, plants are grown in a container filled with a growing medium such as perlite, coconut coir, or vermiculite. A wick, made of materials such as cotton, nylon, or felt, extends from the bottom of the container into a reservoir of nutrient-rich water.

Using a process called “capillary action,” the wick draws up the solution from the reservoir and delivers it to the roots. This allows the plants to absorb the nutrients they need without the need for pumps or electricity.

Wick systems are low-cost and require minimal maintenance. They are also space-efficient, making them an ideal choice for small indoor gardens or balcony gardens. Additionally, wick systems can be used to grow a wide range of plants, from basil and cilantro to leafy greens like butterhead lettuce.

However, wick systems do have some limitations. They may not be suitable for

larger plants that require more water and nutrients, and they are less efficient at delivering nutrients to plants with high nutrient demands. Moreover, wick systems can lead to a buildup of mineral salts in the growing medium, which can harm the plants if not flushed regularly[11].

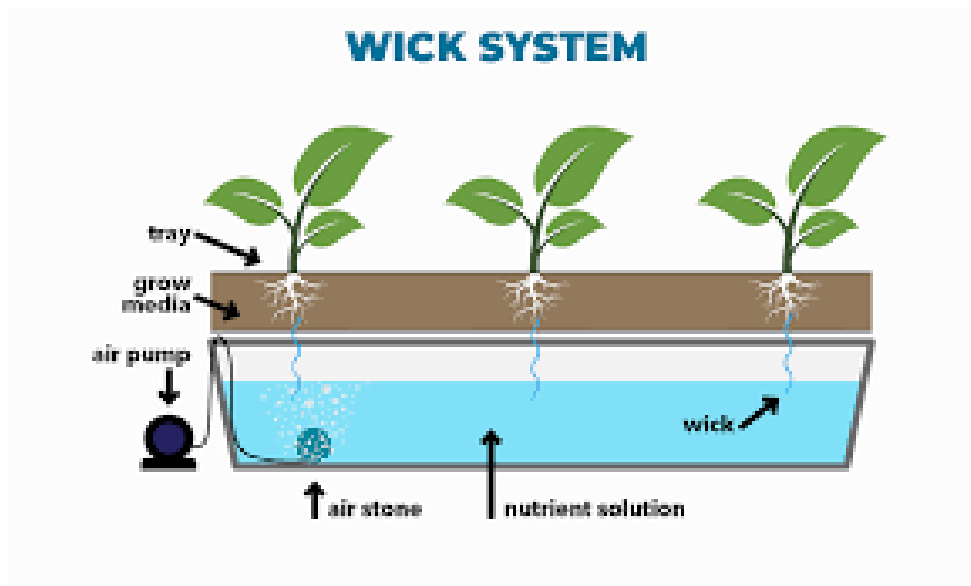

Figure 6: Wick System

1.5 Conclusion:

In this chapter, we explored hydroponics, an innovative method of growing plants without soil, using nutrient-rich water solutions. We discussed the main types of hydroponic systems, including nutrient film technique (NFT), deep water culture (DWC), and aeroponics. The history of hydroponics dates back to ancient civilizations, but it has significantly advanced in the 20th century with modern technological innovations. Hydroponics offers numerous advantages, such as efficient resource use, faster plant growth, and the ability to grow crops in diverse environments. However, despite its benefits, hydroponics can face challenges such as high initial setup costs, dependence on electricity, and the need for constant monitoring and maintenance. These limitations pave the way for exploring aquaponics in the next chapter, which combines hydroponics with aquaculture to create a more integrated and sustainable system.

Chapter 2:

2 Generalities about Aquaponics and ESP32

2.1 Introduction

In this chapter, we expand upon the concept of Smart Aquaponics, a specialized branch of the Smart Farming System that synergizes aquaculture with hydroponics through innovative and sustainable practices. The initial section delves into the essence of Smart Aquaponics, charting its developmental journey and assessing its contemporary role within the sphere of smart agriculture. It elucidates the integral components that constitute a Smart Aquaponics system, encompassing both the technological advancements and biological processes involved.

The subsequent section is dedicated to the ESP32 microcontroller, a pivotal element in the Smart Aquaponics framework. It outlines the microcontroller's historical context and justifies its selection for this specific application. Following this, the chapter provides an in-depth examination of the ESP32's hardware prowess and software architecture, which are crucial for facilitating the automated, eco-friendly operations characteristic of a Smart Aquaponics system. This includes the automation of nutrient delivery, water quality monitoring, and the seamless integration of fish and plant ecosystems to create a self-sustaining agricultural solution.

2.2 What is Aquaponics?:

Aquaponics frequently stands as the initial inquiry in discussions surrounding this innovative project. Essentially, aquaponics is an integrative approach that marries aquaculture—the cultivation of fish in controlled settings—with hydroponics, which is the soilless cultivation of plants. In this symbiotic system, the nutrient-dense water from fish tanks nourishes the plants. These plants, in turn, purify the water, allowing it to circulate back to the fish, thus creating a self-sustaining cycle that diminishes the need for external fertilizers and filtration systems.

The defining features of our aquaponics system are its smart automation and sustainable energy sources, which modernize the traditional aquaponics framework. Unlike conventional systems that demand considerable manual labor, our design operates with minimal human intervention, requiring attention only for replenishing consumables such as for harvesting. This system's adaptability also extends

its application beyond industrial settings, making it a versatile solution for diverse environments[12].

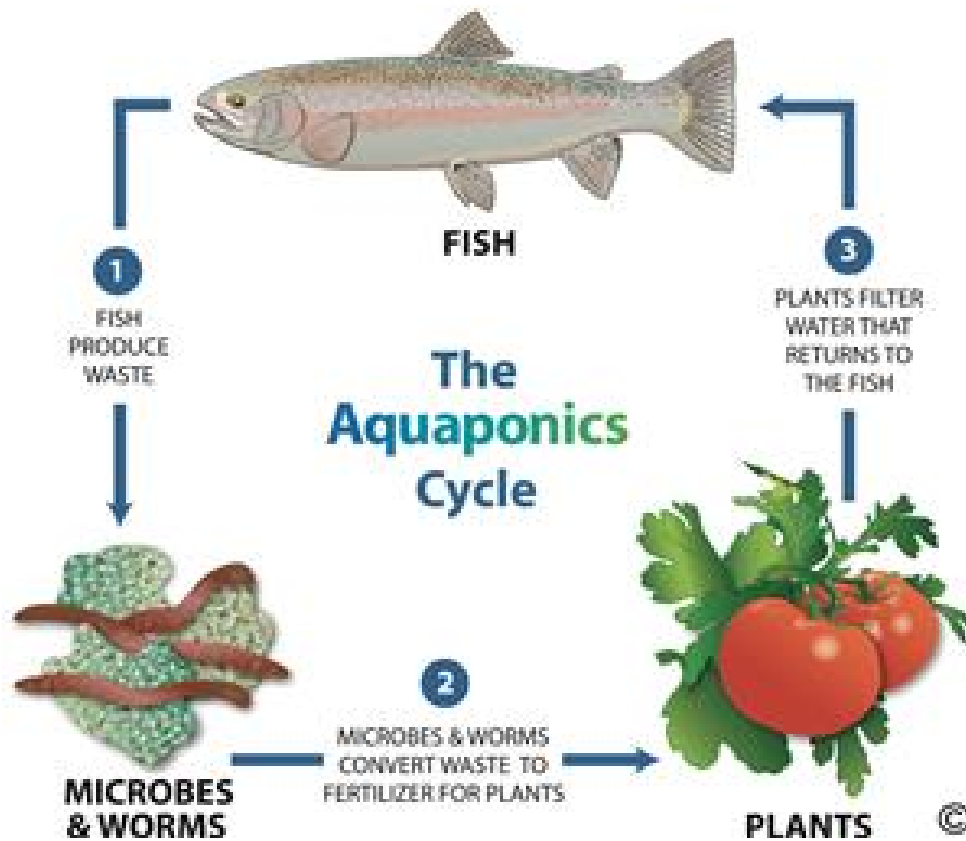

Figure 7: The basic flow of an aquaponics system (What is Aquaponics)

2.3 Types of aquaponics

Aquaponics systems are typically categorized into three fundamental designs: Media-Based, Raft, and Nutrient Film Technique. However, with ongoing advancements in the field of aquaponics, new designs have emerged and are being adopted by practitioners. Among these new developments are the Vertical Aquaponics System and the Hybrid System:[13].

2.3.1 Media Based Aquaponics System

Media-based aquaponics systems utilize a substrate, or "media," to host beneficial bacteria essential for converting fish waste into plant-usable nitrogen. Without these bacteria, water would become toxic for fish, and plants would suffer nutrient deficiencies. Common media types include expanded clay pebbles, lava rock, and gravel, offering a porous surface for bacterial colonization and stability for plant

roots to access nutrients[14].

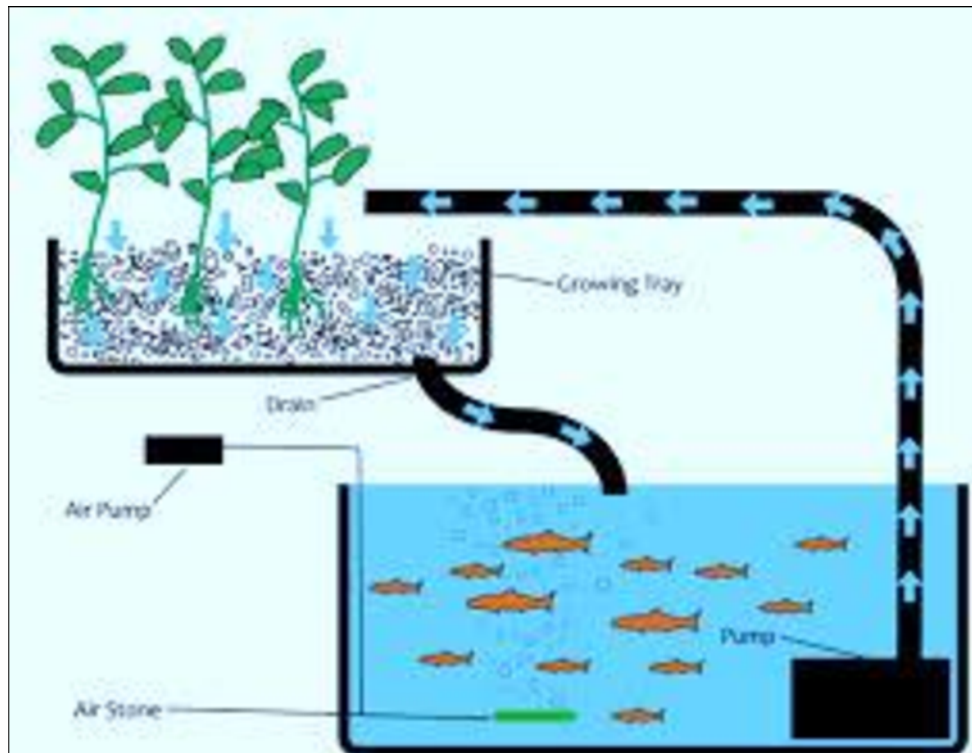

Figure 8: Media-based aquaponic system

2.3.2 Nutrient Film Technique (NFT) Aquaponics Systems

In the Nutrient Film Technique (NFT), a shallow layer of nutrient-rich water flows through horizontal pipes. Plants, held in net pots, are positioned within holes on the top of the pipes, allowing their roots to make contact with the water. This water delivers nutrients to the plants, enabling them to develop robust root systems within the pipes, while their stems and leaves extend out and around the pipes as they grow[15].

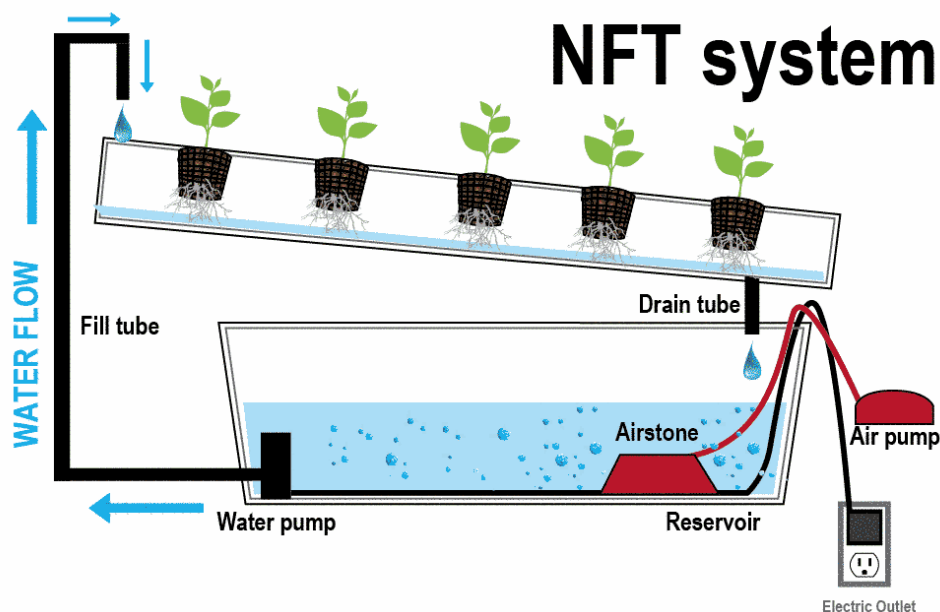

Figure 9: Nutrient Film Technique (NFT) Aquaponics Systems

2.3.3 Raft Aquaponics System

The pros of raft systems include a low capital investment compared to other aquaponic systems, and their ability to stabilize root zone temperatures. If you're familiar with plant function, you know that plant roots aren't built for rapid temperature change, so keeping temperatures steady is key to plant health. Raft systems have a lot of thermal mass in the hundreds of gallons of water in the troughs. This makes it more difficult to change water temperature, and root zone temperatures are kept steady as a result.

On the other hand, raft systems typically don't cut down labor and are limited to one "layer" of production (stacking troughs is difficult and not usually worth the costs). This impacts space use efficiency, which is sometimes a deciding factor for farmers. Two other important needs of raft systems are the need for aeration, and for frequent monitoring of pumps.

The nature of raft systems makes them great for tropical climates. In the tropics, labor is often a marginal cost of production, and the large thermal mass (lots of water = lots of thermal mass) helps to stabilize root zone temperatures in the heat. Tropical climates or climates of the deep South (U.S.) are where DWC truly shines. Other situations where raft systems make sense might have very cheap space, low labor costs, and/or very limited startup costs. [16].

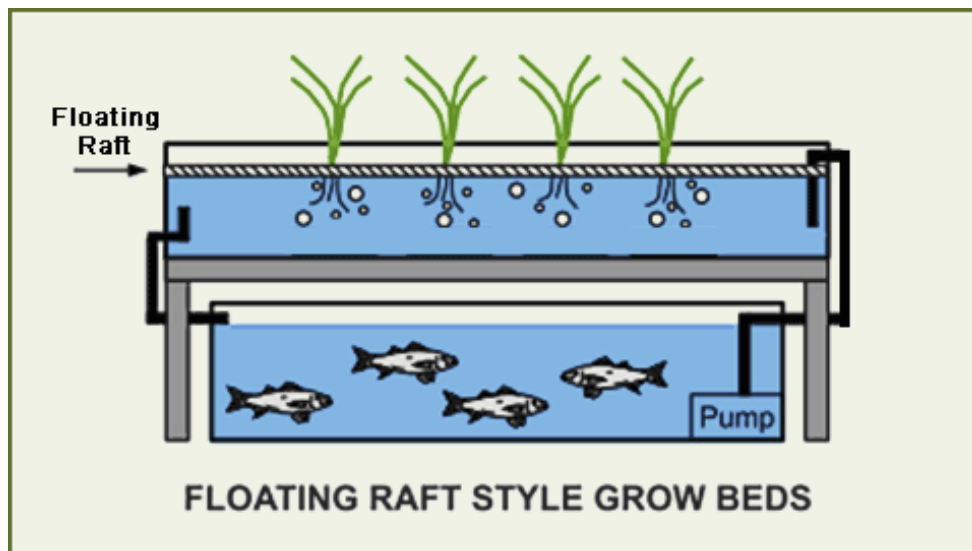

(a) Raft Aquaponics System

2.3.4 Vertical Aquaponics

Vertical Aquaponics is the process of growing fish and plants by circulating water with fish waste to plants that are placed above the tank through a pump. It takes up little space and allows clean oxygenated water for the fish while providing plants with nutrients they get from the fish waste[17].



Figure 11: Vertical Aquaponics

2.4 ESP32 Platform

The ESP32 series, developed by Espressif Systems, is a lineup of cost-effective, energy-efficient system-on-chip microcontrollers featuring integrated Wi-Fi and dual-mode Bluetooth capabilities. These microcontrollers utilize various processors including the Tensilica Xtensa LX6 in both dual-core and single-core configurations, the Xtensa LX7 dual-core processor, or a single-core RISC-V processor. They come equipped with built-in antenna switches, RF balun, power amplifier, low-noise receive amplifier, filters, and power management modules. Manufactured by TSMC using their 40 nm process, the ESP32 serves as a successor to the ESP8266 microcontroller[18].

2.4.1 Why ESP32?

The ESP32 microcontroller platform has gained significant popularity for several reasons:

1. **Integrated Connectivity:** ESP32 chips come with built-in Wi-Fi and Bluetooth capabilities, making them suitable for a wide range of IoT applications without requiring additional hardware components.
2. **Cost-Effective:** Despite its powerful features, the ESP32 platform remains affordable, making it accessible to hobbyists, students, and professionals alike.
3. **Low Power Consumption:** ESP32 devices are designed to be energy-efficient, making them suitable for battery-powered applications where power consumption is a concern.
4. **Versatility:** With a rich set of peripherals including GPIO pins, SPI, I2C, UART, ADC, DAC, and more, the ESP32 can interface with various sensors, actuators, displays, and other external devices.
5. **Dual-Core Processing:** The ESP32's dual-core processor allows it to handle multiple tasks simultaneously, providing improved performance and multi-tasking capabilities compared to single-core microcontrollers.
6. **Open-Source Community:** The ESP32 platform has a large and active open-source community, contributing libraries, examples, tutorials, and documentation to support developers and facilitate learning.

7. **Compatibility:** ESP32 devices can be programmed using popular development environments such as the Arduino IDE, MicroPython, or the ESP-IDF (Espressif IoT Development Framework), offering flexibility and ease of use for developers with different skill levels and preferences.

Overall, the ESP32 platform offers a compelling combination of features, performance, affordability, and community support, making it a preferred choice for a wide range of IoT projects and applications.

2.4.2 Hardware

- **Wi-Fi and Bluetooth Capabilities:** Supports 802.11b/g/n Wi-Fi standards with speeds up to 150 Mbps, Bluetooth v4.2 BR/EDR, and Bluetooth LE specifications.

- **Virtual Wi-Fi Interfaces and Modes:** Features multiple virtual Wi-Fi interfaces and supports Infrastructure Station, SoftAP, and Promiscuous modes for versatile connectivity options.

- **Hardware:** Powered by Xtensa single/dual-core 32-bit LX6 microprocessors for high performance and efficiency. Includes 448 KB ROM, 520 KB SRAM, and 16 KB SRAM in RTC.

- **Peripheral Interfaces:** Offers 34 programmable GPIOs, SAR ADC, DAC, touch sensors, SPI, I2S, I2C, UART, SD/eMMC/SDIO, Ethernet MAC, CAN, RMT, Motor PWM, and LED PWM for versatile interfacing capabilities.

- **Power Management:** Fine-resolution power control with five optimized power modes, achieving ultra-low power consumption in Deep-sleep mode.

- **Security Measures:** Implements secure boot, flash encryption, OTP, and cryptographic hardware acceleration for AES, SHA-2, RSA, ECC, and RNG, ensuring robust security for applications.

Overall, the ESP32 is a highly integrated and versatile microcontroller platform suitable for a wide range of IoT and embedded applications, offering robust Wi-Fi and Bluetooth connectivity, powerful hardware features, and advanced power management capabilities.[19].

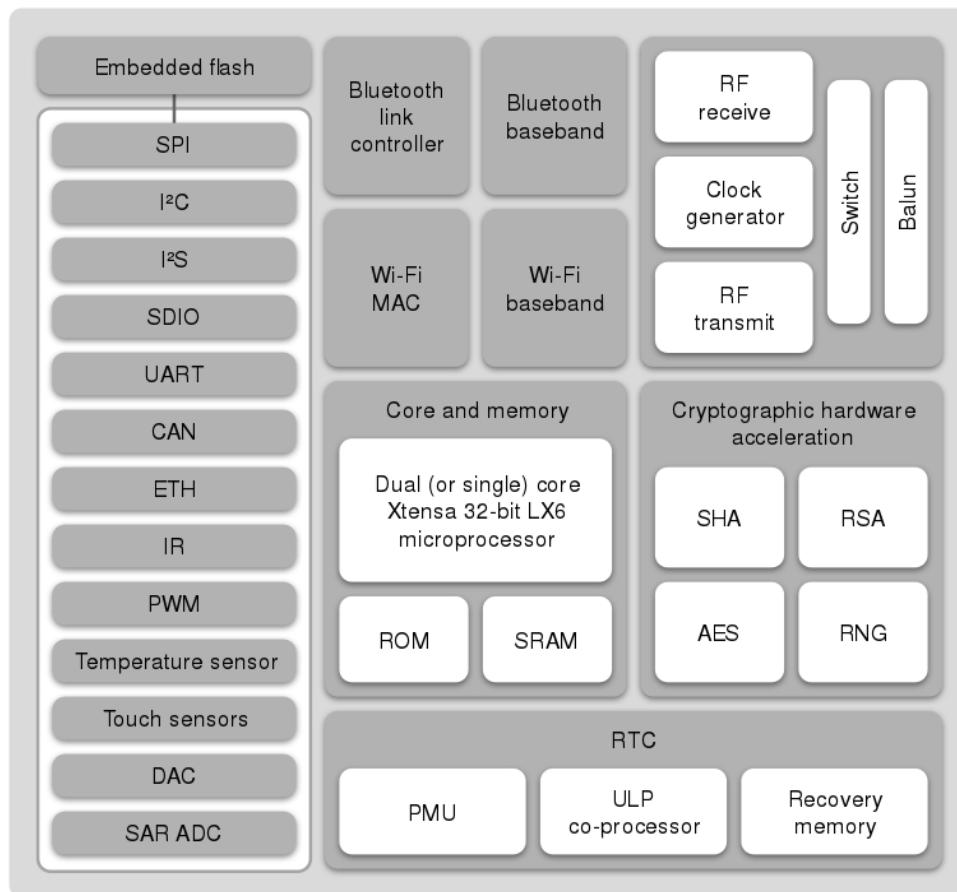

Figure 12: esp32 architecture

2.4.3 Software

- ESP32 software stack includes ESP-IDF, Arduino Core for ESP32, and MicroPython. - Various libraries available for networking, sensors, displays, and communication protocols. - Development tools like esptool, serial terminal emulators, and IDEs aid in programming and debugging. - ESP-IDF provides low-level programming capabilities, while Arduino Core simplifies development for Arduino users. - MicroPython offers a high-level scripting interface for rapid prototyping. - Extensive ecosystem supports both low-level and high-level development approaches. - Flexibility in choosing the appropriate development environment based on project requirements and developer preferences. - Overall, ESP32 software ecosystem facilitates efficient application development for a wide range of IoT and embedded projects.

2.5 The Internet of Things (IoT):

2.5.1 BLYNK:

Blynk's comprehensive platform provides all the tools necessary for building and managing connected hardware:

- Device provisioning: Simplified process for setting up and connecting hardware devices to the Blynk platform.
- Sensor data visualization: Easily visualize and interpret sensor data in real-time through intuitive dashboards and graphs.
- Remote control with mobile and web applications: Control connected devices remotely using mobile apps or web interfaces.
- Over-the-air firmware updates: Seamlessly update device firmware remotely, ensuring continuous improvement and bug fixes.
- Private cloud: Securely store and manage data in a private cloud environment, ensuring data privacy and confidentiality.
- Data analytics: Analyze collected data to gain insights and make informed decisions about device performance and user behavior.
- User and access management: Manage user accounts and access permissions to ensure security and data integrity.
- Alerts and automations: Set up alerts and automate actions based on predefined conditions, enhancing device functionality and responsiveness.

Entrepreneurs, engineers, and large enterprises leverage Blynk's low-code platform to develop user-friendly IoT applications and effectively manage devices, data, and customers within a secure cloud environment[20].

2.5.2 Thing speak

ThingSpeak is an IoT analytics service designed for aggregating, visualizing, and analyzing live data streams in the cloud. It offers instant visualizations of data sent by devices, along with the capability to execute MATLAB code for online analysis. Typically used for prototyping and proof-of-concept IoT systems requiring analytics, ThingSpeak supports data transmission via Rest API or MQTT from any internet-connected device.

Furthermore, cloud-to-cloud integrations with platforms like The Things Network, Senet, Libelium Meshlium gateway, and Particle.io enable sensor data transmission over LoRaWAN® and 4G/3G cellular connections to reach ThingSpeak.

This facilitates seamless connectivity and data collection from various sources.

With ThingSpeak, users can store and analyze data in the cloud without the need for configuring web servers. Moreover, sophisticated event-based email alerts can be created, triggered by incoming data from connected devices, enhancing monitoring and automation capabilities[21].

2.5.3 MQTT protocol

The MQTT protocol is a standards-based messaging protocol used to facilitate machine-to-machine communication and is widely used in Internet of Things (IoT) devices such as smart sensors and wearables. This protocol is characterized by its lightweight and efficient design, requiring minimal implementation and consuming few resources, making it suitable for devices with limited capabilities like micro-controllers. It also boasts high scalability, supporting communication with a large number of devices. MQTT provides features to ensure reliable communication even in networks with low bandwidth and high latency, offering three levels of Quality of Service (QoS) to ensure message delivery. Additionally, it enhances security by simplifying message encryption and device authentication using modern protocols like OAuth and TLS 1.3. Furthermore, it is widely supported by programming languages like Python, making it easy for developers to quickly implement it in various applications[22].

2.5.4 NODE-RED

Node-RED represents a robust framework designed for crafting IoT applications, focusing on simplifying the integration of code blocks to execute tasks. It utilizes a visual programming model where developers connect predefined blocks of code, called nodes, to achieve specific functionalities. These nodes—comprising input, processing, and output components—are interconnected to create operational flows.

Initially developed by IBM as an open-source project to facilitate rapid communication among devices, web services, and software, Node-RED swiftly evolved into a versatile tool for IoT programming. Originally tailored for IoT environ-

ments—where devices interact with and manage their environments—it has expanded its utility to cater to diverse application scenarios[23].

2.6 Conclusion:

After exploring the concept of aquaponics, its types, and the reasons for choosing the ESP32 in IoT applications, we can see how this technology can enhance smart agriculture. Using the ESP32, with its various features like integrated connectivity, cost-effectiveness, low power consumption, and versatility, can significantly improve the efficiency of aquaponics systems. By integrating IoT, environmental conditions can be precisely monitored and controlled, leading to increased productivity and resource sustainability. Combining these advanced technologies opens new horizons for sustainable and innovative agriculture.

chapter 3

3 Prototype and Development

3.1 Introduction

In This chapter presents the design and implementation of a prototype Smart Farming System. We discuss the integrated approach to combining hardware and software components, illustrating the system’s architecture through diagrams and schematics. The software design is explained using flowcharts, revealing the algorithmic logic behind the bio-feeding process and environmental monitoring.

3.2 Components:

3.2.1 ESP32:



Figure 13: ESP32

3.2.2 RTC:

A Real-Time Clock (RTC) is an integrated circuit designed to keep track of time. It utilizes a backup battery to maintain accurate timekeeping even if the main power source is disconnected[22].

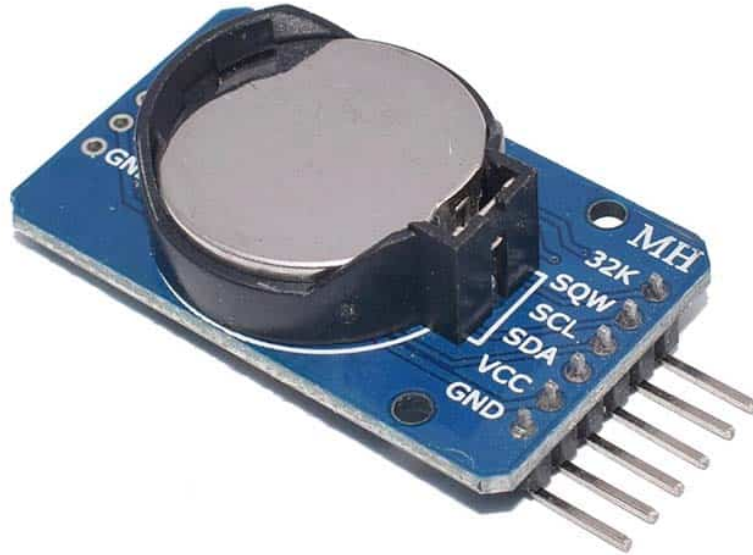

Figure 14: rtc real time clock

3.2.3 PH sensor:

In most cases, the standard pH range is represented by a value in the range of 0-14. When a substance has a pH value of 7, this is considered neutral. pH values above 7 represent higher alkalinity, while substances with pH values below 7 are considered more acidic. For example, toothpaste usually has a pH of 8-9. On the other hand, stomach acid has a pH of 2.

The distinction between alkaline and acidic substances is important for any company that uses cooling towers, boilers, manufacturing processes, pool control and various environmental monitoring. The standard pH of the human body is 7.4, which is essential for the body to function effectively. If the body's composition becomes too acidic or too alkaline, it will appear to revert to a neutral state[23].



Figure 15: PH sensor

3.2.4 Total Dissolved Solids(tds) sensor:

The Grove - TDS Sensor measures the Total Dissolved Solids (TDS) levels in water, providing an indication of water quality. This sensor is suitable for various water quality applications, including TDS meters, well water monitoring, aquariums, and hydroponics. It supports 3.3V to 5V input voltage and outputs 0 to 2.3V, ensuring compatibility with all Arduino boards. Additionally, the sensor comes with a waterproof probe, simplifying the testing process[24].

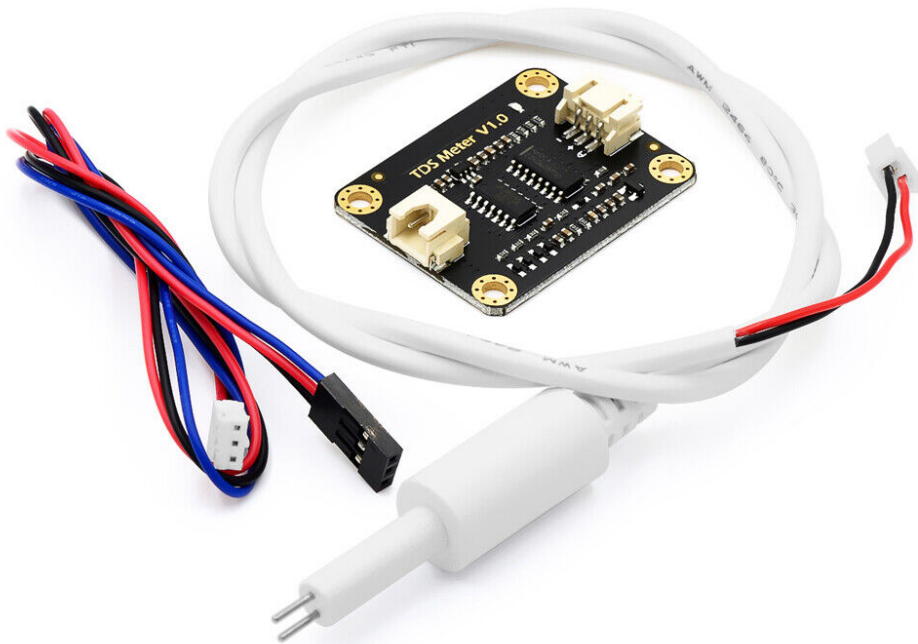

Figure 16: Total Dissolved Solids(tds) sensor

3.2.5 Waterproof 1-Wire DS18B20 Digital temperature sensor:

This pre-wired and waterproofed version of the 1-Wire DS18B20 sensor, protected with heat shrink, is perfect for measuring temperatures in distant or wet conditions. The sensor can handle temperatures up to 125°C, but the PVC-jacketed cable should be kept below 100°C. These digital sensors maintain signal integrity over long distances and provide accurate readings with a precision of $\pm 0.5^{\circ}\text{C}$ across most of their range. They offer up to 12-bit resolution from the onboard digital-to-analog converter. Compatible with any microcontroller using a single digital pin, multiple sensors can be connected to the same pin, each having a unique 64-bit ID burned in at the factory for identification. They are suitable for 3.0-5.0V systems.

The main drawback is the use of the Dallas 1-Wire protocol, which is somewhat complex and requires extensive code to parse the communication. For a simpler

solution that uses an analog input pin, the TMP36 is a great alternative.

A 4.7k resistor is included[25].



Figure 17: Waterproof 1-Wire DS18B20 Digital temperature sensor

3.2.6 Relay Module (8 Channels - 5V) :

This relay module features 8 relays, each connected to a current buffer, allowing direct connection to a microcontroller or Arduino. With these relays, you can effortlessly control high-power devices or appliances using Arduino or microcontrollers. Each relay is rated for 230V and 10 amps. The module includes 5 LEDs: one for power indication and four for signaling the relay status[26].

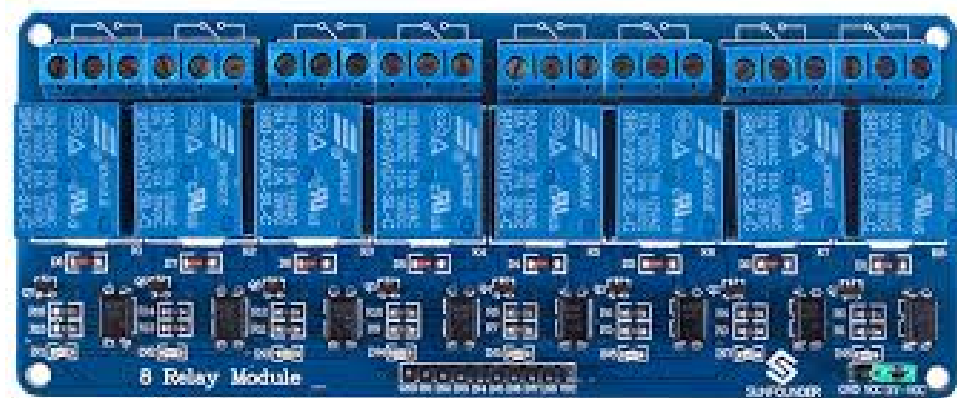

Figure 18: Relay Module (8 Channels - 5V)

3.2.7 servo motor:

Servo motors are actuators that can be either rotary or linear. They are equipped with an integrated position sensor, allowing for precise control of their position, whether in rotational or linear movements[27].

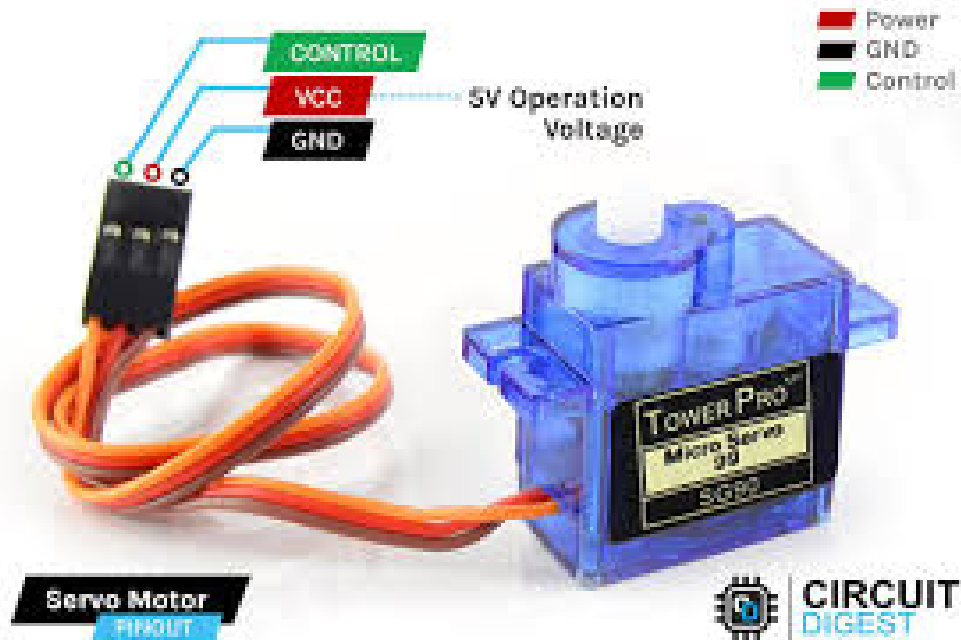

Figure 19: servo motor

3.3 Electrical Design :

The electronic design of the control system is illustrated in Figure 20. The microcontroller used is an ESP32, which comes with a development/programming board. The programming language is very similar to C but includes several libraries that facilitate the control of I/O ports, timers, and serial communication. This microcontroller was chosen due to its low price, ease of reprogramming, and simplicity of the programming language.

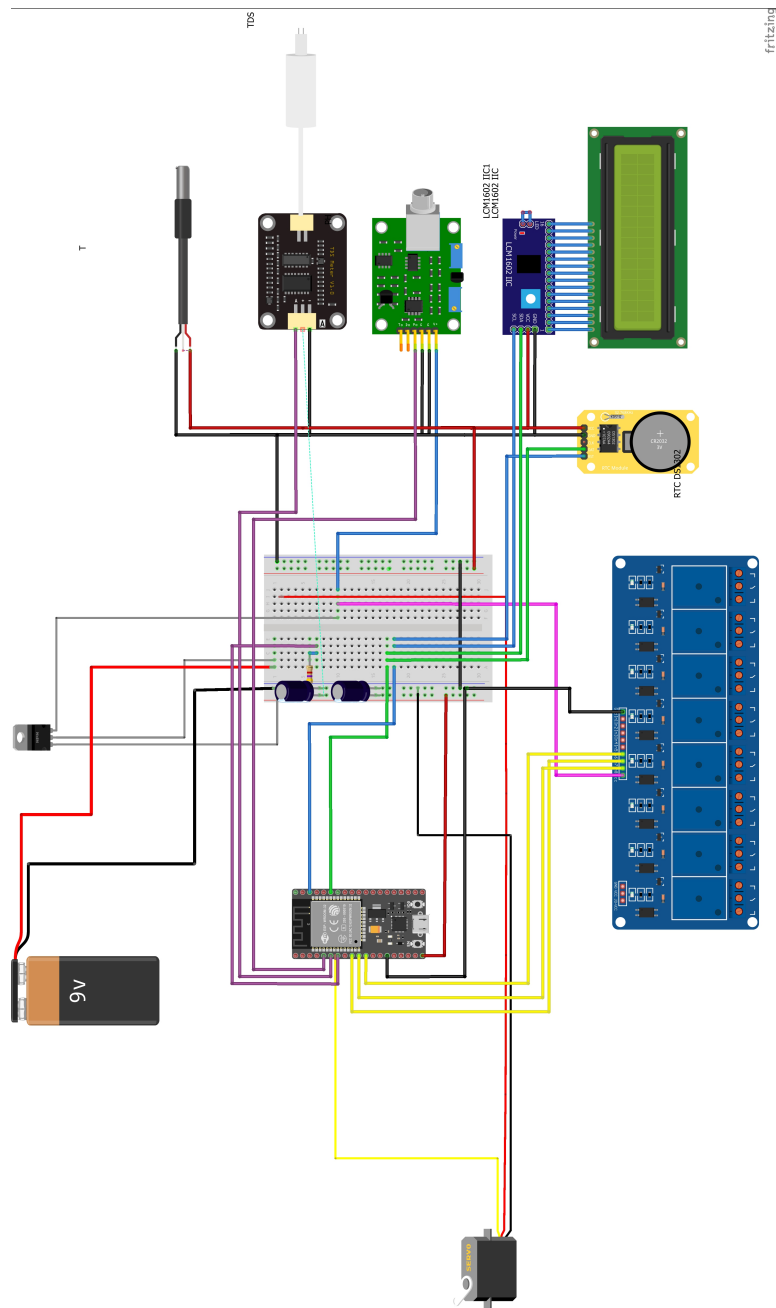

Figure 20: Circuit diagram

3.4 Software :

This flowchart outlines the setup and main loop operations of a smart farming system using an ESP32 microcontroller. The process begins with system initialization, connecting to WiFi, and establishing an MQTT connection. The Real-Time Clock (RTC) is checked and configured if necessary. In the main loop, the system continuously reads sensor data (temperature, TDS, pH), updates the servo position based on this data, publishes sensor readings to the MQTT broker, and displays information on an LCD screen. Additionally, the system handles irrigation and

water change operations at predefined intervals, while also checking for incoming MQTT control messages to adjust operations as needed. This ensures efficient and continuous monitoring and control of the smart farming environment.

Figure 21: Flowchart of the Initial Setup and Main Loop Operations

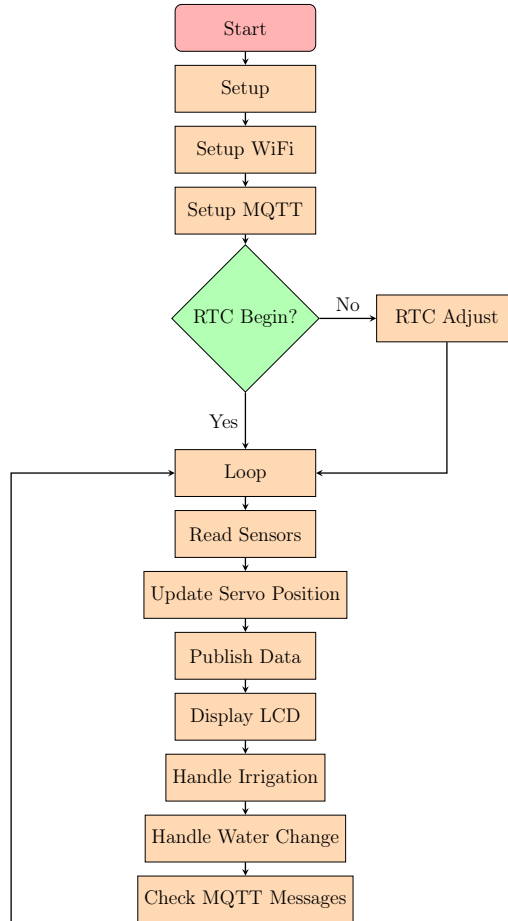

3.5 Fuzzy Logic :

Fuzzy logic is employed in this system to manage the position of the servo motor based on temperature readings. Unlike traditional binary logic, which operates on a true/false basis, fuzzy logic handles degrees of truth, making it ideal for scenarios

requiring nuanced control.

In this smart farming system, fuzzy logic helps adjust the servo motor to dispense food based on temperature variations. The fuzzy logic system interprets temperature data and translates it into servo positions, ensuring optimal functioning of the system. This approach allows for smooth and precise adjustments, accommodating the natural variability in sensor readings.

The fuzzy logic system is defined by three fuzzy sets for the temperature input: cold, warm, and hot. Similarly, the output for the servo position is categorized into three fuzzy sets: low, medium, and high. These sets are used to create rules that determine the servo position based on the input temperature.

Fuzzy Logic Rules:

Table 1: Fuzzy Logic Rules for Servo Position Control

Rule	Condition	Servo Position
1	If Temperature is Cold	Then Servo Position is Low
2	If Temperature is Warm	Then Servo Position is high
3	If Temperature is Hot	Then Servo Position is Medium

3.6 MQTT (Message Queuing Telemetry Transport):

Specifies the MQTT server used to communicate, in which case it is "test.mosquitto.org", ESP32 is connected to WiFi, and then an MQTT client is created using the PubSubClient library. Two main topics are specified: one for disseminating sensor data and one for subscribing to control commands. The device is confirmed to be connected to the MQTT server, and if the connection drops, the device attempts to reconnect automatically. When receiving messages from the MQTT server, the message is analyzed and appropriate action is taken based on its content, such as turning pumps on or off or controlling the servo position. Sensor data such as temperature, TDS levels, and pH are published to the server regularly.

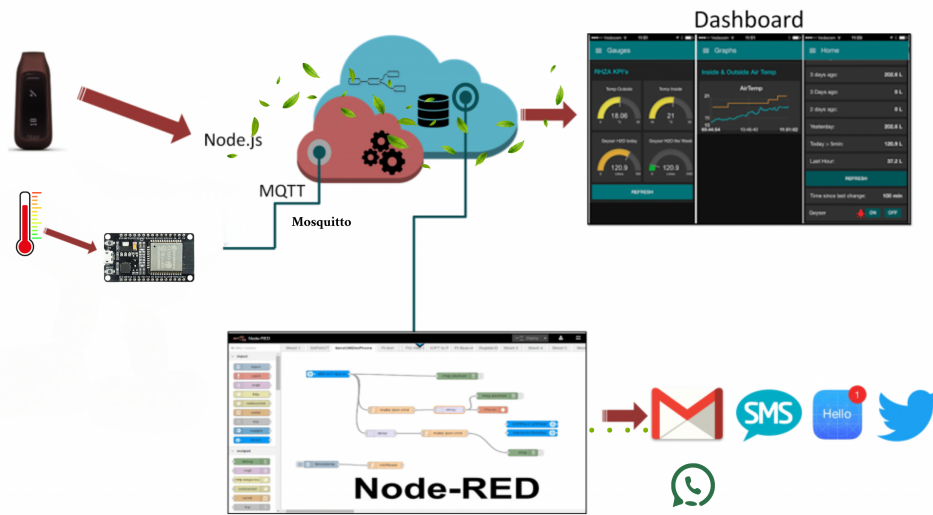

Figure 22: How MQTT Protocol Works with NODE RED

3.7 Node-RED:

In the aquaponics system built on Node-RED, data from temperature, TDS, and pH sensors are received via MQTT nodes, with data being sent periodically to specific MQTT topics. The data is then displayed on the dashboard using widgets like gauges to show the current values directly. Users can also control the irrigation system, change the water, and feed the fish through control buttons on the dashboard, sending commands via MQTT to various systems to execute the desired actions, thus providing effective monitoring and complete control over the system.

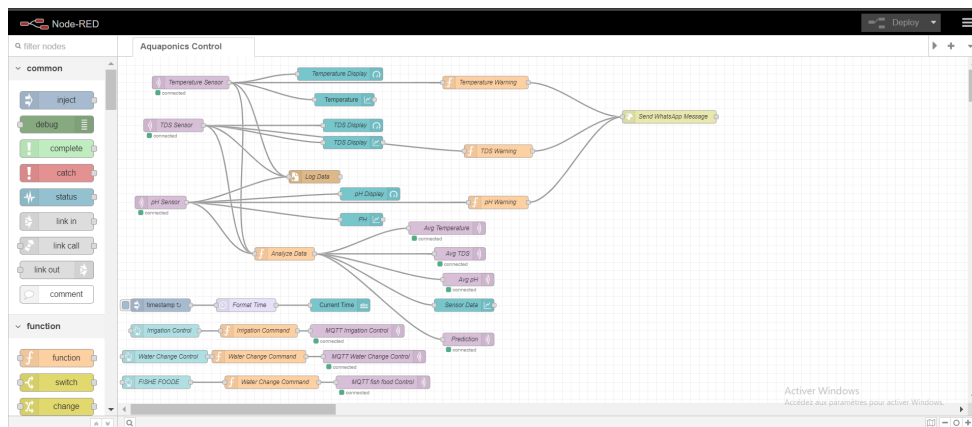

Figure 23: NODE RED FLAW

3.8 Model Deployment

The circuit has been implemented according to it as shown in Figure 24.



(a) Prototype (a)



(b) Prototype (b)

Figure 24: Prototype

3.9 Conclusion

In this chapter, we developed and implemented a prototype of an aquaponics system based on the ESP32 platform, merging aquaculture and hydroponics seamlessly. We utilized advanced automation techniques such as fuzzy logic and MQTT protocol for effective monitoring, sensor data management, and remote control capabilities. MQTT facilitated rapid and secure data transmission across various devices, ideal for IoT applications. Node-RED served as our tool for easy integration and data flow management between components and services.

This preliminary model marks an initial stride towards building an intelligent and sustainable aquaponics system, blending hydroponic and traditional farming methods innovatively. By refining technology integration and enhancing automated system performance.

General Conclusion

General Conclusion

In conclusion, this project represents the design and implementation of an integrated aquaponics system based on the ESP32 platform, which enhances the optimal balance between aquatic and agricultural environments. The system ensures ideal conditions for the growth of plants and fish by integrating a set of sensors to monitor vital factors such as temperature, pH levels, and total dissolved solids (TDS). Advanced automation technologies such as fuzzy logic and the MQTT protocol facilitate remote monitoring and management, providing an efficient and sustainable solution for farmers. Additionally, the use of a servo motor to feed the fish adds an extra level of automation and convenience, reducing the need for constant human intervention.

However, it is important to note some challenges encountered during the implementation of this project, most notably the lack of sensors and their high cost. Accurate and reliable sensors are essential to ensure effective and precise monitoring, but acquiring them can be expensive and difficult, posing an obstacle to the widespread application of this technology.

Future Work

In the future, the system can be developed to include artificial intelligence features to analyze the collected data more effectively and make intelligent control decisions based on advanced analytics. Furthermore, data collection and analysis techniques can be integrated to continuously improve system performance by learning from past data and automatically adapting to environmental changes. These developments will contribute to making the system more sustainable and efficient, offering innovative solutions to enhance agricultural production and encourage the integration of technology with the environment.

References

- [1] Chiang Liang Kok, I Made Bagus Pradnya Kusuma, Yit Yan Koh, Howard Tang, Ah Boon Lim, *Smart Aquaponics: An Automated Water Quality Management System for Sustainable Urban Agriculture*, *Electronics*, vol. 13, no. 5, pp. 820, 2024. <https://www.mdpi.com/2079-9292/13/5/820>
- [2] Muthumanickam Dhanaraju, Poongodi Chenniappan, Kumaraperumal Ramalingam, Sellaperumal Pazhanivelan, Ragunath Kaliaperumal, *Smart Farming: Internet of Things (IoT)-Based Sustainable Agriculture*, *Agriculture*, vol. 12, no. 10, pp. 1745, 2022. <https://www.mdpi.com/2077-0472/12/10/1745>
- [3] Eden Green Technology, *What is Hydroponics?*, Eden Green Technology Blog, September 29, 2020. <https://www.edengreen.com/blog-collection/what-is-hydroponics>
- [4] Growlink, *A Brief History of Hydroponics*, Growlink Blog, May 2024. <https://blog.growlink.com/a-brief-history-of-hydroponics>
- [5] Air Garden, *Types of Hydroponic Systems*, Air Garden Blog, May 2024. <https://airgarden.com.au/blogs/news/types-of-hydroponic-systems>
- [6] Ponics Life, *Deep Water Culture (DWC) Systems: A Complete Guide for Hobbyists*, Ponics Life, 2024. <https://ponicslife.com/deep-water-culture-dwc-systems-a-complete-guide-for-hobbyists>
- [7] Ponics Life, *Nutrient Film Technique (NFT): A Complete System Guide*, Ponics Life, 2024. <https://ponicslife.com/nutrient-film-technique-nft-a-complete-system-guide/>
- [8] FloraFlex, *The Hydroponic Drip System Explained*, FloraFlex, 2024. <https://floraflex.com/default/blog/post/the-hydroponic-drip-system-explaine>
- [9] Modern Farmer, *How Does Aeroponics Work?*, Modern Farmer, 2018. <https://modernfarmer.com/2018/07/how-does-aeroponics-work/>

- [10] Get Growee, *Hydroponic Ebb and Flow System*, Get Growee, 2024. <https://getgrowee.com/hydroponic-ebb-and-flow-system/>
- [11] Ponics Life, *Hydroponic Wick System: The Best System for Beginners*, Ponics Life, 2024. <https://ponicslife.com/hydroponic-wick-system-the-best-system-for-beginners/>
- [12] Ryan Toal, Kevin Claggett, Justin Goh, *Smart and Sustainable Aquaponics*, Santa Clara University Scholar Commons, June 15, 2017. https://scholarcommons.scu.edu/cgi/viewcontent.cgi?article=1035&context=elec_senior
- [13] Go Green Aquaponics, *The Different Types of Aquaponics Systems*, Go Green Aquaponics, 2023. <https://gogreenaquaponics.com/blogs/news/the-different-types-of-aquaponics-system>
- [14] Admin, *Aquaponics Technology: Media-Based Systems*, Urban Fish Farmer, March 6, 2023. <https://urbanfishfarmer.com/aquaponics-technology-media-based-systems/>
- [15] Fisheries and Aquaculture Department (FI) in FAO, *Nutrient Film Aquaponics Unit: Step by Step Description*, FAO TECA, 2020. <https://www.fao.org/teca/en/technologies/8396>
- [16] Amy Storey, *Introduction to the Aquaponic Raft System*, Upstart University, August 8, 2016. <https://university.upstartfarmers.com/blog/intro-aquaponic-raft-system>
- [17] Mateusz Piechowiak, *Vertical Aquaponics: What it is and How it Works*, Vertical Farming Planet, 2024. <https://verticalfarmingplanet.com/aquaponics-in-vertical-farming-what-is-it-and-how-it-works/>
- [18] Espressif Systems, *ESP32 - Wikipedia*, Wikipedia, 2016. <https://en.wikipedia.org/wiki/ESP32>

- [19] Espressif Systems, *ESP32 Series Datasheet*, Espressif Systems, April 2024. https://www.espressif.com/sites/default/files/documentation/esp32_datasheet_en.pdf
- [20] Blynk, *Blynk: a low-code IoT software platform for businesses and developers*, Blynk Website, May 2024. <https://blynk.io/>
- [21] MathWorks, *ThingSpeak - IoT Analytics Platform Service*, MathWorks Website, April 29, 2024. <https://www.mathworks.com/products/thingspeak.html>
- [22] Amazon Web Services, *What is MQTT?*, AWS, accessed June 13, 2024. <https://aws.amazon.com/ar/what-is/mqtt/>
- [23] Geeks Valley, *Node-RED Introduction*, Geeks Valley, accessed June 13, 2024. <https://geeksvalley.com/tutorial/node-red-introduction/>
- [24] Circuit Basics, *How to Use a Real-Time Clock Module with the Arduino*, 2015. <https://www.circuitbasics.com/how-to-use-a-real-time-clock-module-with-the-arduino/>, Accessed: 2024-06-06.
- [25] Apure Instruments, *All About pH Sensor: What is it and How Does it Work?*, 2024. <https://apureinstrument.com/blogs/about-ph-sensor/>, Accessed: 2024-06-12.
- [26] Seeed Studio, *Grove - TDS Sensor*, 2024. <https://wiki.seeedstudio.com/Grove-TDS-Sensor/>, Accessed: 2024-06-12.
- [27] Adafruit, *Adafruit 2.4" Color TFT Touchscreen Breakout*, Adafruit, accessed June 13, 2024. <https://www.adafruit.com/product/381>
- [28] FUT Electronics, *Relay Module 4 Channels 5V*, FUT Electronics, accessed June 13, 2024. <https://store.fut-electronics.com/products/copy-of-relay-module-4-channels-5v>

- [29] Jeem2, *Comparison of Servo Motors in Jeem2 Store*, Jeem2, accessed June 13, 2024. <https://jeem2.com/experiences-and-projects/comparison-of-servo-motors-in-jeem2-store/>

Sources of Images

for Copyright purposes

Figure 1 from https://www.hydroponicsfactory.com/d/images/dwc_02.png

Figure 2 from https://www.austinjbergman.com/content/images/2022/08/2DC11711-FD7A-43CA-8F85-21390E67FB22_1_102_o.jpeg

Figure 3 from <https://www.oysoco.com/images/Hydroponics-Drip-Irrigation-System.png>

Figure 4 from <https://ponicslife.com/wp-content/uploads/2022/05/Aeroponic-System-scaled.jpg>

Figure 5 from https://encrypted-tbn0.gstatic.com/images?q=tbn:ANd9GcTCjaVIeek_CEM_sAwuSUXyq5sEb9S_RtHA0g&s

Figure 6 from <https://www.fusd1.org/cms/lib/AZ01001113/Centricity/Domain/1348/aquaponics%20cycle.jpg>

Figure 7 from <https://www.researchgate.net/profile/Md-Salam-3/publication/301641318/figure/fig2/AS:362342337531905@1463400553104Media-based-aquaponic-system-Mediawiki-2014.png>

Figure 8 from <https://i.pinimg.com/564x/09/f0/c6/09f0c60952a97273940dd1bcec741895.jpg>

Figure 9 from <https://www.evergreenlanefarm.net/css/img/system-graphic.png>

Figure 10 from <https://i.pinimg.com/originals/24/63/fc/2463fc147cab68a81af1a25c71461a4b.jpg>

Figure 11 from https://4.bp.blogspot.com/-Ah0fuS0ZiFk/WRh54T_3YrI/AAAAAAADx4/dWDoRZGgrTwTiXjYnYwGa1sioqf2LvLZwCLcB/s1600/esplayer.png

Sources of Images (continued)

for Copyright purposes

Figure 12 from <https://www.electronicwings.com/storage/PlatformSection/TopicContent/424/icon/ESP32%20GPIO%20Banner%20Image.jpg>

Figure 13 from <https://ielectrony.com/wp-content/uploads/2019/11/NA041.jpg>

Figure 14 from https://m.media-amazon.com/images/I/51pBdF8ajGL._AC_UF1000,1000_QL80_.jpg

Figure 16 from <https://i.ebayimg.com/images/g/~poAAOSwdJNidMLx/s-l1600.jpg>

Figure 17 from <https://cdn-shop.adafruit.com/970x728/381-00.jpg>

Figure 19 from <https://encrypted-tbn0.gstatic.com/images?q=tbn:ANd9GcTMq1og9noze0-AyfIg7y0MODS1dUvwJn9nbg&s>

A Appendix Title

R2-FO-03 E1DZ

الجمهورية الجزائرية الديمقراطية الشعبية
REPUBLIQUE ALGERIENNE DEMOCRATIQUE ET POPULAIRE Demande N°:893

INSTITUT NATIONAL ALGERIEN DE LA PROPRIÉTÉ INDUSTRIELLE **inapi** المعهد الوطني الجزائري للملكية الصناعية

REQUETE EN DELIVREANCE D'UN BREVET D'INVENTION
 طلب منح براءة الإختراع

<p>1 Nature de la demande de protection طبيعة الطلب</p> <p>Brevet d'invention <input checked="" type="checkbox"/> Demande divisionnaire <input type="checkbox"/> Certificat d'addition <input type="checkbox"/> براءة الإختراع <input checked="" type="checkbox"/> طلب جزئي <input type="checkbox"/> شهادة الإضافة <input type="checkbox"/></p> <p>Extension de la demande Internationale PCT <input type="checkbox"/> الإمتداد غير طلب دولي <input type="checkbox"/></p> <p>2 INFORMATIONS SUR LE DEPOSANT معلومات حول مقدم الطلب</p> <p>Dénomination: Université de Ghardaia إسم الشركة</p> <p>Forme juridique: Administration الطبيعة القانونية</p> <p>Secteur d'activité: service قطاع النشاط التجاري</p> <p>Adresse: Zone scientifique, BP 455, Wilaya: Ghardaïa العنوان: Ghardaia, 47000, Algérie الولاية: Ghardaïa Commune: Bounoura البلدية:</p> <p>Téléphone: 0666850103 رقم الهاتف</p> <p>3 CODE DU MANDATAIRE رمز الوكيل</p> <p>Nom du mandataire: <input type="text"/> إسم الوكيل</p> <p>4 INFORMATIONS SUR L'INVENTEUR معلومات حول المخترع</p> <p>Nom et Prénom: HAMD الاسم واللقب: Marouane</p> <p>Nationalité: DZ_Algeria الجنسية</p> <p>Adresse: Cité Mermed, Ghardaia, 47000, Algérie العنوان</p> <p>Fonction: Etudiant المهنة</p> <p>E-mail: marwan202020192018@gmail.com البريد الإلكتروني</p> <p>5 DONNEES RELATIVES A LA PRIORITE بيانات الأولوية</p> <p>Date: <input type="text"/> Numéro: <input type="text"/> تاريخ رقم الأولوية</p> <p>Pays d'origine: <input type="text"/> البلد الأصلي</p>	<p>6 TITRE DE L'INVENTION عنوان الإختراع</p> <p>54</p> <p>Un dispositif automatisé intégré pour l'élevage vertical de plantes et la pisciculture avec bio-alimentation</p> <p>7 DOMAINE TECHNIQUE DE L'INVENTION المجال التقني للإختراع</p> <p>51</p> <p>8 DONNEES RELATIVES AU DEPOT بيانات الإيداع</p> <p>Date: 27 NOV. 2023 تاريخ الوقت</p> <p>Heure: <input type="text"/></p> <p>Numéro: 231849 رقم الإيداع</p> <p>9 DONNEES RELATIVES A LA DEMANDE INTERNATIONAL بيانات الطلب الدولي</p> <p>72</p> <p>Date: <input type="text"/> Heure: <input type="text"/> تاريخ الوقت</p> <p>Numéro: <input type="text"/></p> <p>10 DÉCHÉANCE إبطال</p> <p>La déchéance d'un brevet d'invention intervient en cas de non-acquittement, à la date anniversaire du dépôt, des taxes de maintien en vigueur.</p> <p>يسقط الحق على ملكية براءة الإختراع في حالة عدم تصديد الرسوم السنوية المستحقة</p>
-------------------------------------------------------------------------------------------------------------------------------------------------------------------------------------------------------------------------------------------------------------------------------------------------------------------------------------------------------------------------------------------------------------------------------------------------------------------------------------------------------------------------------------------------------------------------------------------------------------------------------------------------------------------------------------------------------------------------------------------------------------------------------------------------------------------------------------------------------------------------------------------------------------------------------------------------------------------------------------------------------------------------------------------------------------------------------------------------------------------------------------------------------------------------------------------------------------------------------------------------------------------------------------------------------------------------------------------------------------------------------------------------------------------------------------------------------------------------------------------------------------------------------------------------------------------------------------------------------------------------------------------------------------------------------------	-------------------------------------------------------------------------------------------------------------------------------------------------------------------------------------------------------------------------------------------------------------------------------------------------------------------------------------------------------------------------------------------------------------------------------------------------------------------------------------------------------------------------------------------------------------------------------------------------------------------------------------------------------------------------------------------------------------------------------------------------------------------------------------------------------------------------------------------------------------------------------------------------------------------------------------------------------------------------------------------------

CADRE RESERVER A L'INAPI

BOUAÏMEH HAFSI
إطار خاص بالمعهد

Service Dépôt
Chef de Service

SIGNATURE (CACHET)

ختم / توقيع

محر داية

Adresse: 42, Rue Larbi BEN M'HIDI, Alger | E-mail: info@inapi.org | Web : www.inapi.org

Figure 25: This project is registered as a patent

4	INFORMATIONS SUR L'INVENTEUR 2	72	4	INFORMATIONS SUR L'INVENTEUR 3	72
معلومات حول المخترع Nom et Prénom: BOUHADDA الإسم واللقب: Nadir			معلومات حول المخترع Nom et Prénom: HACENE الإسم واللقب: Nacer		
Nationalité: DZ الجنسية: DZ			Nationalité: DZ الجنسية: DZ		
Adresse: Noumérat, Metilli, Ghardala, 47000, Algérie العنوان: Noumérat, Metilli, Ghardala, 47000, Algérie			Adresse: Université de Ghardala, Zone scientifique, BP 455, Ghardala, 47000, Algérie العنوان: BP 455, Ghardala, 47000, Algérie		
Fonction: Etudiant المهنة: Etudiant			Fonction: Chercheur المهنة: Chercheur		
E-mail: nadimini45@gmail.com البريد الإلكتروني: nadimini45@gmail.com			E-mail: hacenenacer77@gmail.com البريد الإلكتروني: hacenenacer77@gmail.com		

Adresse: 42, Rue Larbi BEN M'HIDI, Alger | E-mail: info-dpitt@inapi.org | Web : www.inapi.org
 العنوان: 42 شارع العربي بن مهيدي - الجزائر

Figure 26: This project is registered as a patent.



Figure 27: Permission to print (Master's thesis)